

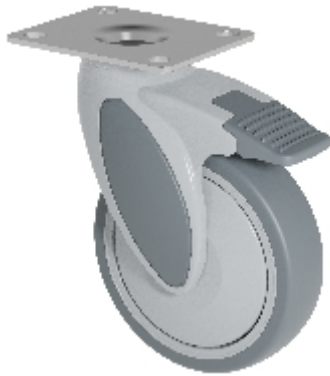

Zwenkwiel met rem/richtingsvastzetter gemonteerd aan achterzijde

KSF2-51C-P100 (VIVAX 2.0)



Technische data

Diameter		125 mm
Wiel breedte		32 mm
Bouwhoogte		168,5 mm
Uitlading		46 mm
Topplaat afmetingen		100x80 mm
Top plate diameter		9 mm
Afstand tussen de boutgaten		80x60/76x55 mm
Draagvermogen		100 kg
Gewicht		720 g

Technische omschrijving

zwenkvork uit hoogwaardig slagvast nylon

zwenkkop met een afgedicht diepgroefkogellager



Wiel

polypropylen wielkern

thermoplastische band (TPE, Shore A 87)
draadbescherming

diepgroefkogellager